

The Effects of Over-Compressing ASTM F959 Direct Tension Indicators on A325 Bolts Used in Shear Connections

EDWIN R. SCHMECKPEPER, RICHARD J. NIELSEN, and GUY GENTRY

ABSTRACT

Direct tension indicators (DTIs) are one alternative method that is commonly used to verify that high-strength bolts have been properly tensioned during installation. This research attempts to resolve questions concerning the use of bolts which may have been overtensioned, as evidenced by DTIs which were completely flattened to zero DTI gaps.

A variety of bolt and DTI combinations were tested to determine how far the nuts could rotate before the bolt fractured. Sets of bolts and nuts with DTIs were then tensioned to the point of incipient failure and tested in single and double shear. These tests indicated there was no significant decrease in the single and double shear strengths of these over-tensioned bolts.

In addition, a series of tests compared the performance of DTIs manufactured per ASTM F959-90 to those manufactured per ASTM F959-96. These tests indicated that the F959-96 DTIs exhibit less variability and indicate higher preloads at the specified DTI gaps compared to those manufactured to F959-90.

INTRODUCTION

As successors to hot-placed rivets, high-strength bolts have been the fastener of choice for over four decades. The sustained clamping force generated by high-strength bolts for slip-critical connections have made them the most accepted fastener for this type of connection. The underlying characteristic of high-strength bolts which makes them so appealing is their ability to provide significant tension loading with or without excessive plastic

deformation. This allows bolts used in slip-critical connections to be reliably tensioned sufficiently to obtain the required clamping and frictional forces.

Several installation methods have been developed to ensure that the high-strength bolts used in bolted connections are adequately tensioned.¹ Studies have verified the reliability of these methods to achieve the minimum tensions specified in Table 4 of the Research Council on Structural Connections (RCSC) specifications or in the AASHTO specifications.¹ Bendigo and Rumpf³ studied bolts tensioned using the turn-of-nut method. Struik, et al.⁴ found that direct tension indicators (DTIs) were as reliable as the turn-of-nut method in ensuring that minimum tension is developed in high-strength steel bolts. Salih, et al.⁵ determined the load-deformation properties of A325 bolts. They also found that DTIs ensure A325 bolts meet or exceed the minimum tension when installed properly. In addition, Salih, et al.⁵ warned against "over-tensioning" bolts, pointing out the lack of satisfactory inspection criteria and the inability to determine bolt tension after complete closure of all measurement gaps in the DTIs. However, they did not investigate the material characteristics of bolts in this state, although in the commentary the RCSC states that turn-of-nut is primarily dependent upon bolt elongation into the inelastic range. Note that inelastic elongation can occur with any bolt tensioning method, and that the DTI method is one that provides evidence that this condition may have occurred.

Very little testing has been performed on bolts where the nut is rotated substantially beyond the point required to ensure minimum tension, some users are concerned that bolts so installed would experience severe inelastic elongation. If inelastic deformations induced by tensioning beyond minimum tension cause a loss of tensile and clamping force, the strength of slip-critical connections might be substantially reduced. The current AASHTO installation specifications express these concerns by requiring that if during the bolt installation, a DTI is compressed so that no visible gaps remain, the DTI must be removed and replaced.²

Edwin R. Schmeckpeper is Associate Professor, Department of Civil Engineering, University of Idaho.

Richard J. Nielsen is Associate Professor, Department of Civil Engineering, University of Idaho.

Guy Gentry is former Graduate Research Assistant, Department of Civil Engineering, University of Idaho.

BACKGROUND INFORMATION

A direct tension indicator (DTI) is a hardened washer-type device with protrusions on one face. When placed under the bolt head (or nut), these protrusions compress as the nut (or bolt head) is rotated and tension is developed in the bolt.

Two accepted methods for installing high-strength bolts using direct tension indicators are outlined by the manufacturer.⁶ The main difference between the two methods lies in the location of the DTI's protrusions in relation to the turned part. The preferred method, Method No. 1 (Figure 1) places the DTI under the stationary bolt head. In contrast, in Method No. 2, DTIs are placed under the "turned" part, which may be either the nut or the bolt head.

In building construction with plain DTIs, the bolt must be tensioned until at least half of the gaps between the protrusions are closed to less than 0.015 inch as determined by the refusal of a tapered feeler gage. For bridge construction, for epoxy coated or galvanized DTIs, the criteria is 0.005 inches.

In this research it was necessary to distinguish between bolts that were at minimum tension and bolts that were significantly over this level of tension. Once all the DTI gaps are completely closed, which is referred to as nil gap, DTIs cannot indicate the amount of elongation, which might be considerable, or if the bolt is tensioned to the point of impending fracture of the bolt. So long as there is some visual gap remaining after the nut rotation, the user is assured that the bolt has not experienced inelastic elongation.

TEST PROGRAM

To determine whether or not bolts tensioned significantly beyond minimum tension perform acceptably, the researchers conducted bolt tension, single shear, and double shear tests on various bolt and DTI configurations, including tests conducted on bolts which were tensioned to minimum tension and on bolts tensioned to a level just

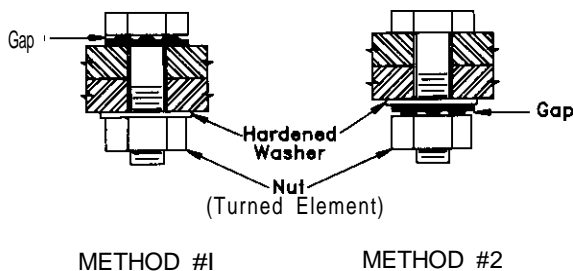

Fig. 1. DTI Installation Methods

before fracture. The test program consisted of three main sections:

- 1) torqued tensile strength,
- 2) concentric compressive double shear strength, and
- 3) eccentric tensile single shear strength.

Three different types of A325 bolts, Type 1-plain, Type 1-galvanized, and Type 3-weathering steel, were tested. The bolts were supplied by two different manufacturers. All bolts were 7/8-inch diameter, with a length of 3-1/2 inches or 5 inches. These bolt dimensions corresponded to those used on a recent Idaho Transportation Department (ITD) bridge project. Plain finished bolts were tested with plain DTIs, galvanized bolts were tested with galvanized DTIs, and weathering steel bolts were tested with epoxy-coated DTIs. These combinations are representative of those most commonly encountered in structural steel design practice. The DTIs for this portion of the test program were supplied by one manufacturer.⁶ All test results presented in this paper used installation Method No. 1, with a hardened washer under the nut. All tests were conducted on bolts with the threads excluded from the shear planes. To provide adequate clamping force, the RCSC Specification¹ requires the bolts to be tensioned to 70% of the minimum specified tensile strength. This level of tension is called "minimum tension." This tension is 39 kips for 7/8-inch diameter A325 bolts.

To ensure uniformity in the testing procedures, all bolts were tested with lubrication applied to their thread area. In addition, the nut was hand-threaded down and up the entire length of the threaded section of the bolt prior to lubricating in an attempt to reduce seizing. Seizing is the binding of the thread-interface between the nut and the bolt which induces significant torsion in addition to elongation as the nut is turned. This twisting action can cause the bolt shank to shear in torsion, possibly before the minimum required tension has been reached.

A Skidmore-Wilhelm, Model "M" bolt tension calibrator was used in the bolt tensile strength tests. A 500K MTS universal testing machine was used to conduct the shear tests. Bolt torquing was achieved through the use of a manually operated 600 ft-lb capacity torque wrench, augmented with a 4x torque multiplier, yielding a maximum possible torque capacity of 2400 ft-lb. DTI gap measurements were read with both standard and manufacturer supplied tapered feeler gauges. Tapered feeler gauges more readily locate the gaps between DTI protrusions; however, both sets of feeler gauges gave comparable gap readings.

Torqued Tensile Strength Test

The purpose of the torqued tensile strength tests was to determine the relationship between nut rotation, DTI gap

measurement, and bolt tension. These tests served to define the point at which bolts developed tension in excess of minimum tension.

Torqued-tension evaluation of bolt specimens was performed with the Skidmore-Wilhelm bolt calibrator. Using this apparatus, DTI gap measurements were correlated with nut rotation and bolt tension readings.

The RCSC Specification defines snug-tight as the tightness that exists when the plies of the joint are in firm contact¹ such that subsequent nut rotation results in elongation of the bolt. The specification reads, "Snug tight can usually be attained by a few impacts of an impact wrench or the full effort of an ironworker using an ordinary spud wrench."

Due to the smooth finish on the test plates and the lubrication applied to the bolt threads, very low applied torques brought the plies of the connection into firm contact and produced bolt tension readings on the Skidmore-Wilhelm bolt calibrator. This initial Skidmore-Wilhelm reading was used as the starting point for all subsequent testing. After this initial Skidmore-Wilhelm reading, the bolt head, nut, and bolt shank were marked with reference lines, which were used to determine the rotation of the nut relative to the bolt shank and the bolt shank relative to the bolt head during subsequent testing. For each bolt length and material, a minimum of three specimens were tested. Test specimens were sequentially torqued in 50 ft-lb increments. At each increment, DTI gaps, bolt tension, and nut to shank rotation were measured and recorded. As a final check, the reference marks on the bolt head and shank were inspected for signs of relative head to shank rotation, which was then recorded. Once the DTI gaps were closed too tight to permit entry of the thinnest feeler gauge, DTI gap measurements could no longer provide any additional information about the bolt tension. Nut to shank rotation and bolt tension measurements were continued until the bolt fractured. Note that due to the presence of the protrusions on the DTIs, the nut rotation vs. bolt tension for nuts and bolts tested with DTIs will be different than that obtained using the turn-of-nut method on nuts and bolts without DTIs.

Concentric Compressive Double Shear Strength

The purpose of the concentric compressive double shear strength tests was to determine the compressive shear strength of bolts subjected to various degrees of tension. The apparatus used in testing ultimate compressive double shear is similar to that described in Appendix A of the RCSC Specification for Structural Joints Using ASTM A325 or A490 Bolts.¹

All bolts tested in double shear were 5-inches long in order to exclude all threads from the shear planes (Figure 2). For each type of bolt material, tests were conducted on bolts which were untensioned, tensioned to minimum

tension, and tensioned to near the point at which the bolt was about to rupture. Using the results of the Torqued Tensile Strength tests, the tension required to rupture a bolt was estimated by monitoring the nut rotation and level of effort required to turn the nut.

Once a specimen reached the desired degree of tension, it was placed in the universal test machine and loaded to failure. The load vs. displacement information for each bolt was recorded to obtain the maximum ultimate concentric compressive double shear strength. This data allowed for the comparison of concentric compressive double shear strengths for these three conditions of tension.

Eccentric Tensile Single Shear Strength

The purpose of the eccentric tensile single shear strength tests was to determine the tensile shear strength of bolts subjected to various degrees of tension. The bolts tested in eccentric tensile single shear were placed in the apparatus shown in Figure 3. This arrangement loaded the bolts in single shear. Two bolts were loaded simultaneously to avoid eccentric loads on the testing apparatus; however, the single shear loading is slightly eccentric. This eccentricity was introduced to simulate typical two-ply connections.

Bolts loaded in eccentric single tensile shear, as in the double compressive shear tests, were manually torqued. This test was conducted using 3.5-inch long weathering steel bolts, which were torqued to 0,260,360 and 540 degrees of nut rotation past the torque which had produced

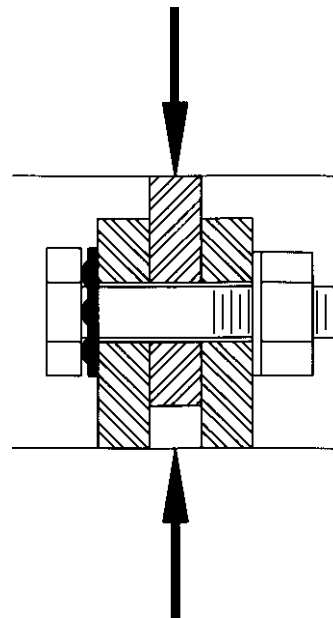

Fig. 2. Concentric Compressive Double Shear Apparatus

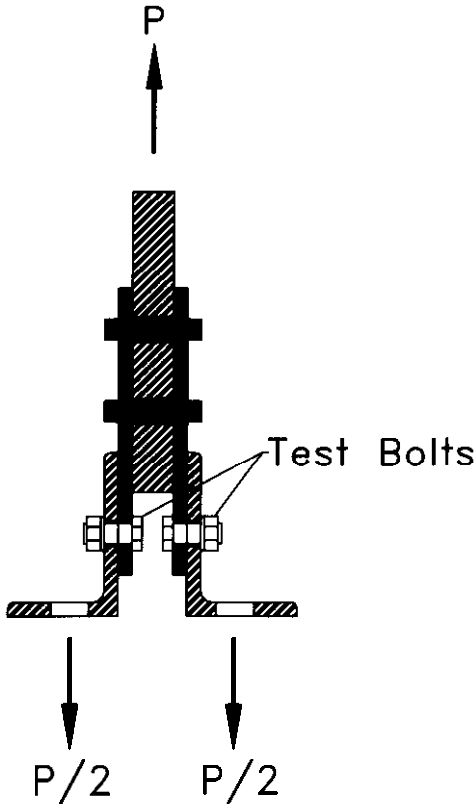

Fig. 3. Eccentric Tensile Single Shear Test Apparatus

initial readings on similar bolts in the Skidmore-Wilhelm bolt calibrator, using the methodology described in the previous section.

Since the bolts were tested in pairs, a total of eight bolts were loaded in eccentric tensile single shear.

TEST RESULTS

Torqued Tensile Strength Test Results

The test results from the concentric compressive double shear strength tests on the plain, galvanized and weathering steel 7/8-inch diameter A325 bolts are summarized in Table 1.

Due to the combined tension-torsion stress introduced by the friction between the nut and the gripped portion of the bolt as the nut is rotated, bolts tensioned using torque will have as much as a 25% reduction in strength compared to bolts in direct tension.⁹ The tension-torsion stress combination is evidenced by the rotation of the bolt shank relative to the bolt head (Figure 4), which in a pure tension test, or during service, does not occur. This effect was particularly noticeable in the 5-inch long plain finished bolts and 3.5-inch long galvanized bolts.

Based upon the information provided on the mill certification sheet, the ultimate tensile strength of the weathering steel bolts in direct tension was 72.1 kips for the 3.5-inch bolts and 69.0 kips for the 5-inch long bolts. The ratio of the torqued tension strength to direct tension strength was 0.85 for the 3.5-inch weathering steel bolts and 0.87 for the 5-inch long weathering steel bolts.

| Test I.D. | Bolt Type | Bolt Length (Inches) | Mean Nut Rotation to Min. Tension (degrees) | Mean Ultimate Load (Kips) | Mean Nut Rotation to Ultimate Load (degrees) | Mean Rupture Load (Kips) | Mean Nut Rotation to Rupture Load (degrees) |
|--|-----------|----------------------|---|---------------------------|--|--------------------------|---|
| PTT-1,2,3 | P | 3.5 | 270 | 50.5 | 400 | 43.0 | 660 |
| PTT-4 ^a ,5 ^a ,6 ^b | P | 5 | 320 | 42.8 | 350 | 32.8 | 560 |
| GTT-1 ^a ,2 ^a ,3 ^a | G | 3.5 | 300 | 45.3 | 430 | 39.3 | 600 |
| GTT-4,5,6 | G | 5 | 330 | 49.7 | 490 | 41.7 | 760 |
| WTT-1,2,3 | W | 3.5 | 280 | 61.3 | 540 | 53.0 | 900 |
| WTT-4,5,6 | W | 5 | 310 | 60.3 | 570 | 53.0 | 940 |

Bolt Type: P = Plain, G = Galvanized, W = Weathering
^aBolt shank rotation > 30 degrees
^bBolt shank rotation > 45 degrees
 Bolt tension was measured using a Skidmore-Wilhelm Bolt Tension Calibrator.

Bolt tension vs. DTI gap reading for plain bolts, galvanized bolts, and weathering steel bolts, are shown in Figure 5, Figure 6, and Figure 7. These figures indicate that when the average DTI gap reached the specified 0.015 inches or 0.005 inches, the bolts had reached minimum tension.⁷

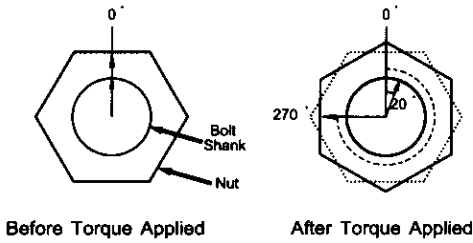

Fig. 4. Bolt Shank and Nut Rotation During Tightening

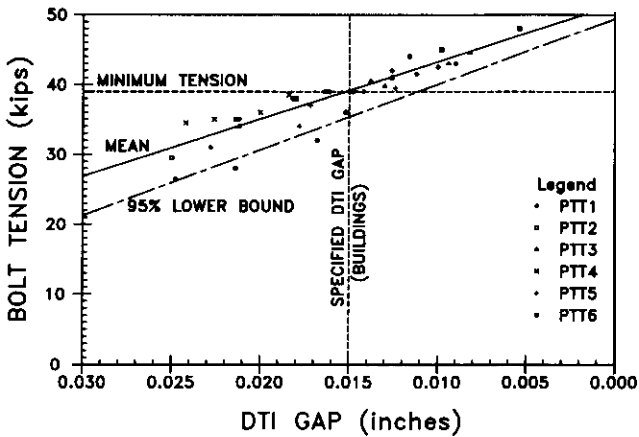

Fig. 5. Bolt Tension vs. DTI Average Gap, 7/8-in. A325 Plain Bolts with Plain DTIs

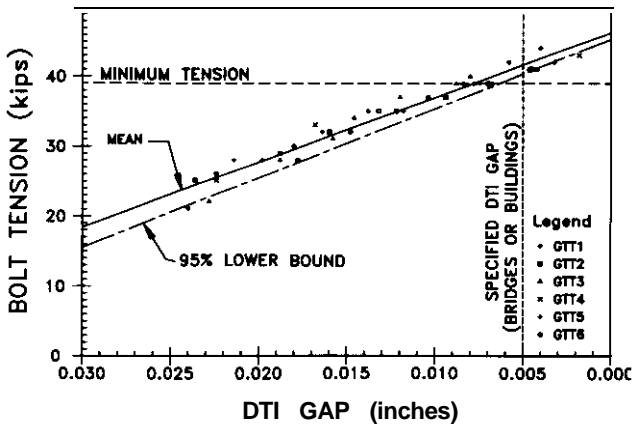

Fig. 6. Bolt Tension vs. Average DTI Gap, 7/8-in. A325 Galvanized Bolts with Galvanized DTIs

Figure 5 indicates that while the average bolt tension was above the minimum tension, the 95% lower bound value was several thousand pounds below the specified minimum tension. Note that the DTIs used in these tests were manufactured to ASTM F959-90. Additional tests were conducted on DTIs manufactured to ASTM F959-96 as a follow up to this first portion of the test program. The results of these additional tests are shown in the Appendix.

Normalized torqued tension vs. nut rotation for 3.5-inch and 5-inch weathering steel 7/8-inch diameter A325 bolts were plotted in Figure 8 and Figure 9. Plain or galvanized A325 bolts perform similarly. The bolt tension measurements were normalized with respect to the minimum tension of 39 kips. In each of these plots one can see the four

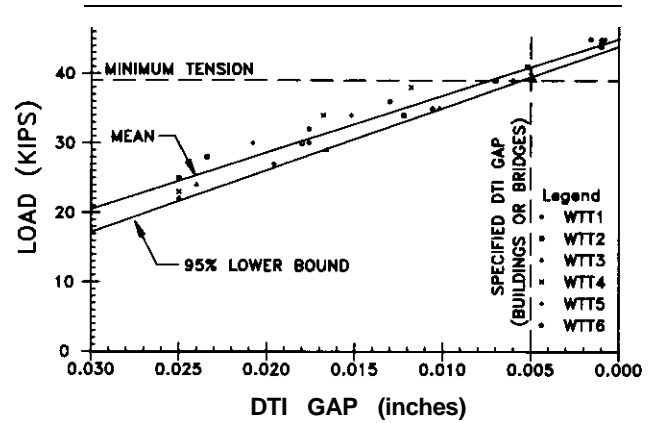

Fig. 7. Bolt Tension vs. Average DTI Gap, 7/8-in. A325 Weathering Steel Bolts with Epoxy Coated DTIs

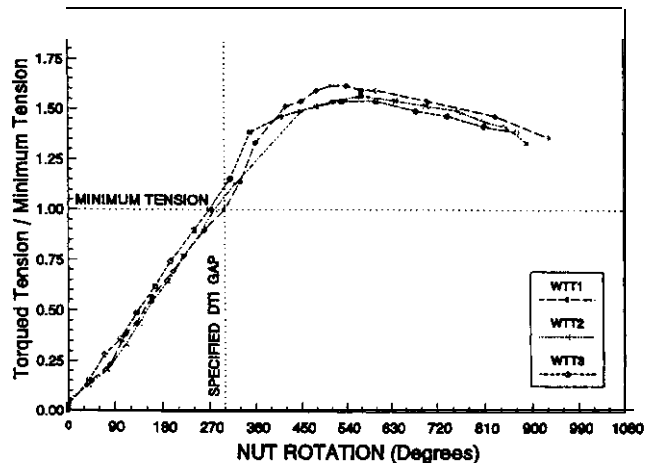

Fig. 8. Normalized Torqued Tension vs. Nut Rotation: 7/8-in. A325 Weathering Steel Bolts & Epoxy-Coated DTIs, 3.5" Bolt Length

distinct characteristics expected in a load vs. deflection plot of a ductile metal:

- 1) a linear initial section,
- 2) a proportional limit,
- 3) an ultimate point, and finally
- 4) a rupture failure point.

The transition from linear to yielding behavior typically occurs when the bolt reaches a tension of 35% or more over the minimum tension. This transition occurs after the closure of the DTI gaps to the specified limits, as indicated by the vertical lines on Figure 8 and Figure 9. This indicates that the bolts had not experienced inelastic elongation when the specified DTI gap was achieved. Note that the ultimate load did not occur until approximately 210 to 240 degrees of nut rotation past minimum tension, substantially past the point at which the DTI was completely flattened.

For the weathering steel bolts, the minimum specified tension and DTI gap closure limits were reached at nut rotations of 300 to 330 degrees.

Rupture of the bolts occurred at total nut rotations ranging from approximately 560 degrees to more than 940 degrees depending on the bolt type and grip length. To determine the effects of over-rotation in the subsequent single and double shear tests, the bolts were tensioned as much as possible without rupturing them. The over-rotated plain bolts and galvanized bolts had nut rotations of 540 degrees, and the over-rotated weathering steel bolts had rotations of 720 degrees. While preparing over-rotated specimens for shear testing, several plain and galvanized bolts were ruptured just before achieving the rotations specified, indicating these rotation limits were appropriate.

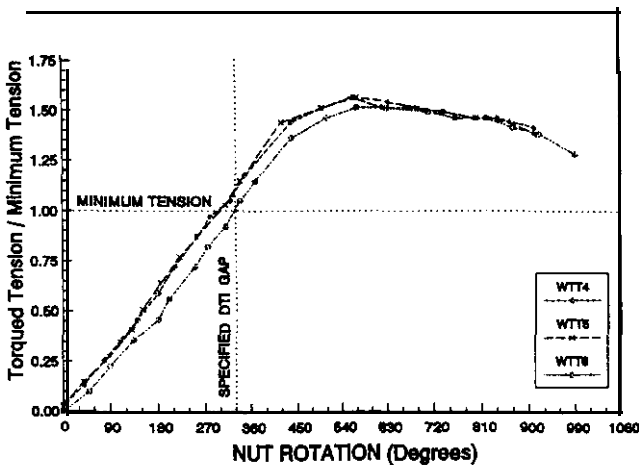

Fig. 9. Normalized Torqued Tension vs. Nut Rotation: 7/8-in. A325 Weathering Steel Bolts & Epoxy-Coated DTIs, 5.0" Bolt Length

Concentric Compressive Double Shear Strength Test Results

The test results from the concentric compressive double shear strength tests on the plain, galvanized and weathering steel bolts are summarized in Table 2.

These results are illustrated in Figure 10, which shows Normalized Shear Load vs. Nut Rotation. Loads were normalized by taking the ratio of the experimentally recorded maximum shear strength and the nominal shear strength for bolts with no threads in the shear planes given by:

$$Rn = (0.60F_u^b)mA_b \quad (1)$$

| Test I.D. | Bolt Type | Nut Rotation (degrees) | Average Maximum Shear (Kips) |
|---------------|------------|------------------------|------------------------------|
| PCS-1,2,3 | Plain | 0° | 108 |
| PCS-4,5,6,7 | Plain | 360° | 109 |
| PCS-8,9,10,11 | Plain | 540° | 110 |
| GCS-1,2 | Galvanized | 0° | 112 |
| GCS-3,4,5 | Galvanized | 360° | 112 |
| GCS-6,7 | Galvanized | 540° | 113 |
| WCS-1,2 | Weathering | 0° | 114 |
| WCS-3,4,5 | Weathering | 360° | 115 |
| WCS-6,7,8 | Weathering | 740° | 113 |

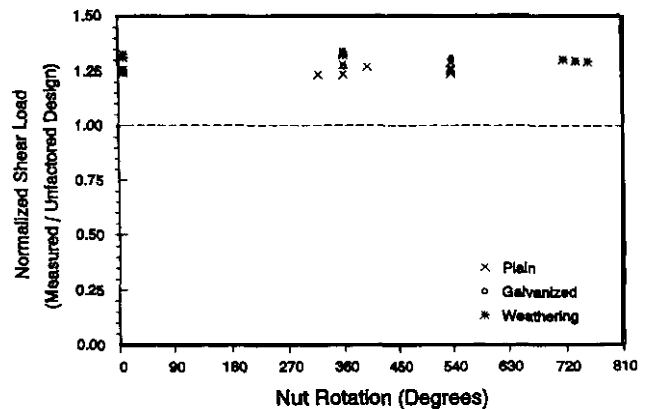

Fig. 10. Normalized Compressive Double Shear vs. Nut Rotation, 7/8-in. A325 Bolts, 5-in. Grip Length

where

- R_n = Unfactored nominal shear strength of fastener
- 0.60 = Shear strength / Tensile strength
- F_u^b = Tensile strength of bolt material (120 ksi for A325 bolts)
- m = Number of shear planes
- A_b = Gross cross-sectional area across shank of bolt

The unfactored nominal shear strength for 7/8-inch diameter A325 bolts in double shear is 86.6 kips.

There are several mechanisms which may introduce tensile stresses in the bolts tested in shear:

- 1) the prying action of the shear plates,
- 2) banding of the bolt, and
- 3) the tension induced during the installation of the bolt.

Struik et al.⁴ indicated that tensile stresses equal to 20% to 30% of a bolt's tensile strength have insignificant effects on its shear strength.

For symmetrical double-shear connections, such as in the compressive double-shear test apparatus shown in Figure 2, the prying action is negligible. Bending of the bolt is believed to increase axial tension as a bolt approaches ultimate load. However, the axial load introduced by this effect is believed to be even smaller in comparison to those introduced by prying action.⁸ Bolt deformation was evident in all bolts tested in double shear (Figure 11). Upon inspection of the test apparatus after loading each bolt to failure, local deformations in the test fixture plates were also noted. These effects were visible in the form of ovaling, etching and raising of the lips around the bolt holes of

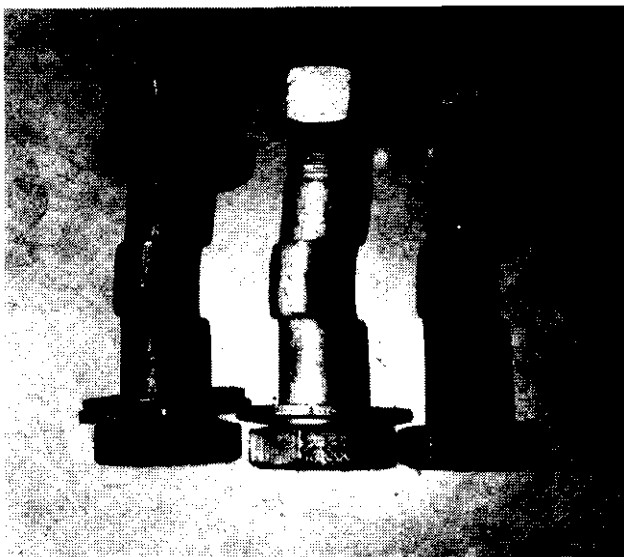

Fig. 11. Bolts Tested in Compressive Double Shear

the side and center plates of the compression shear testing apparatus.

Since the shear capacity was adequate, it was observed that bolt bending, local deformation effects, and prying actions had a negligible effect on shear capacity. The information presented in Figure 10 indicates that there was no evidence that shear capacity is a function of the degree to which an A325 high-strength bolt is tensioned. The information presented in this figure agrees with the conclusion that the primary factor controlling shear capacity is the cross-sectional area available to the shear plane.⁹ If a bolt is tensioned to any degree short of that which causes rupture, the bolt's shear capacity will not be diminished and will be controlled solely by the material area available to the shear plane, as long as the clamping force is not reduced excessively.

Eccentric Tensile Single Shear Strength Test Results

The test results from the eccentric tensile single shear strength testing of weathering steel bolts are summarized in Table 3 and plotted in Figure 12.

| Test I.D. | Bolt Type | Nut Rotation (degrees) | Mean Maximum Shear/Bolt (Kips) |
|-----------|------------|------------------------|--------------------------------|
| WTS1 | Weathering | 0° | 53.0 |
| WTS2 | Weathering | 260° | 52.5 |
| WTS3 | Weathering | 360° | 55.5 |
| WTS4 | Weathering | 540° | 56.0 |

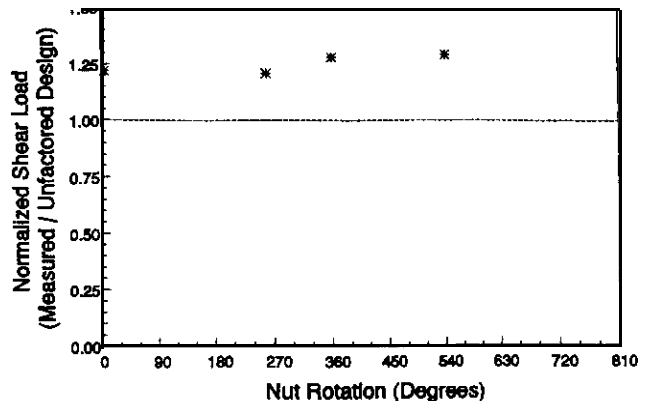

Fig. 12. Normalized Eccentric Single Shear vs. Nut Rotation, 7/8-in. A325 Weathering Steel, 3.5 in. Grip Length

Figure 12 indicates the maximum shear strength in each test normalized with respect to the unfactored single shear capacity of a 7/8-inch diameter A325 bolt, which is calculated to be 43.3 kips.

Prying action, catenary action, and preload loss can affect the shear capacity of bolts tested in eccentric single tensile shear. With the addition of eccentricity to the testing apparatus, a fourth factor must now also be considered: the combined tension and shear components introduced by the eccentricity of the connection.

While it is true that the effects of prying action are more significant in eccentric shear loading conditions than in concentric shear loading conditions, researchers have found these effects remain small in comparison to direct tension effects for normally tensioned bolts." Each of these first three factors are believed to act the same in eccentric single tensile shear as in concentric compressive double shear. Tests done on A325 bolts and their combined loading conditions" have shown that as grip length increases so does ultimate load capacity in single eccentric shear. For these tests, 3.5.inch length bolts were chosen to provide a grip length representative of single-ply connections.

As shown in Figure 12, all bolts tested had a normalized eccentric single shear capacity above the nominal capacity, i.e., above unity in the plots. Again, we see that the eccentric single shear capacity of bolts tested was not significantly diminished by the degree to which the bolt was tensioned, by catenary action, prying action, loss of preload, or combined loading conditions. Prying effects were evident in all bolts tested in single shear (Figure 13).

The test apparatus, due to the eccentricity of the loading, showed even more signs of prying and catenary action than the concentric double-shear tests. However, this additional prying action and catenary action caused no discernible reduction in shear capacity. Any tensioning short of that causing bolt rupture was observed to have no effect on the bolt's eccentric single shear capacity as long as the clamping force was not reduced below proof load. The ultimate capacity of the bolts tested in eccentric single tension shear was found to be a function only of the area available to the shear plane.

SUMMARY AND CONCLUSIONS

The principal result of the investigation into the effects of systematically over-compressing DTIs used with high-strength bolts used in bolted connections was that there was no evidence of a significant loss of bolt shear capacity.

Some secondary observations were also made during the course of this investigation:

- For the A325 weathering steel bolts, a drop in shear capacity of between 8 and 13% was not observed when

comparing concentric compression to eccentric tension shear as cited by previous researchers.⁹

- Bolts tensioned by the DTI method adequately achieved average minimum tension.
- To function properly as load indicating devices, DTIs must be installed properly. Both contractor and inspector should review proper installation techniques before each project to ensure that DTIs are being installed and inspected properly.
- There were no significant differences between the bolts from the two manufacturers.

The results of this research were found to be consistent with recent and historical studies reported in literature. The current AASHTO specification requirement of the removal and replacement of overcompressed DTIs is conservative. However, due to inspection constraints, specific modifications to the current installation practices governing the usage of DTIs are not proposed.

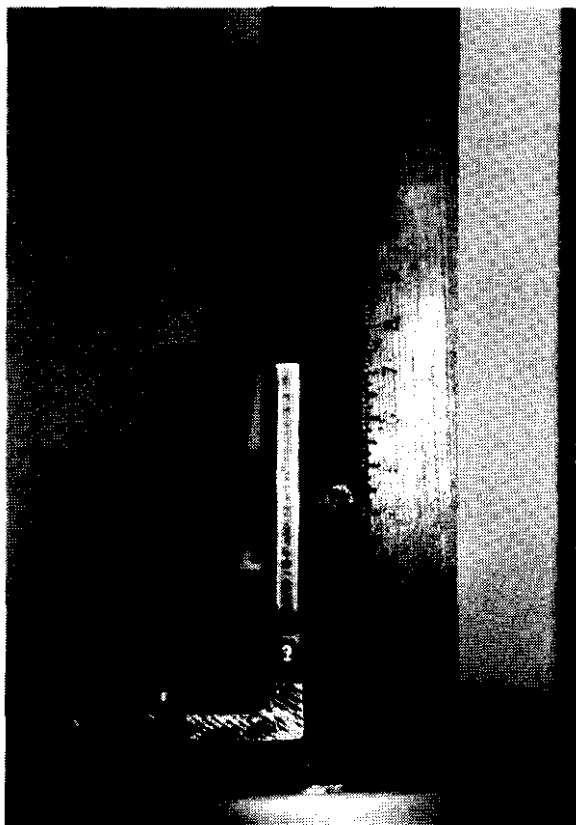

Fig. 13. Eccentric Single Shear Test Apparatus after Testing

APPENDIX

Follow Up Testing of DTI Performance

After the principle portion of this test program was completed, revisions to ASTM F959 resulted in changes in the design and testing of DTIs.

One key change is in the method used to test DTIs. In ASTM F959-90⁷ the gap measurements were made with either a feeler gauge or a dial gauge. For A325 bolts, the DTI gap of 0.015 inches was used for plain finished DTIs and a gap of 0.005 inches was used for epoxy coated or galvanized DTIs. The DTI could be tested in a test frame or a bolt tension indicator, such as the Skidmore-Wilhelm (Figure 14).

In ASTM F959-96 Annex A12 the gap measurements are made with a direct reading gage using a two step load procedure (Figure 15). The revised test procedure uses calibrated support and bearing blocks to apply compression loads on the DTIs, and requires the "use of a system calibrated to an accuracy of 1 % or better per ASTM E4. In the

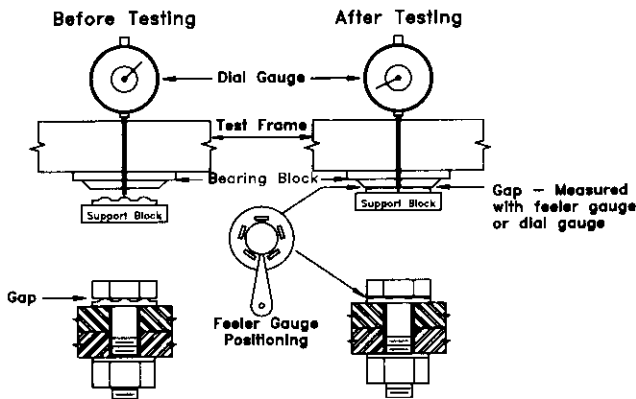

Fig. 14. ASTM F959-90 Test Assemblies

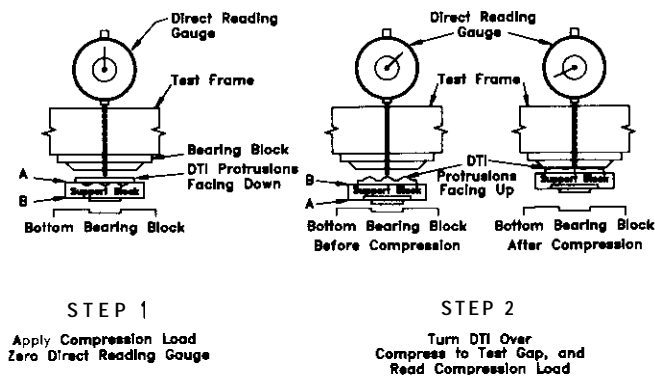

Fig. 15. ASTM F959-96 Annex A1 Test Assemblies

first step, a load equal to the minimum required load on the DTI is applied to the apparatus and the direct reading gage is set to a zero reading. In the second step, the compression load is applied to the DTI until the gage reads 0.015 inches. In contrast to the requirements of ASTM F959-90, this gap measurement is used for all DTI finishes. Finally, in F959-96, field testing of direct tension indicators for bolt tension is delegated to a nonmandatory appendix. The DTI gaps specified in F959-96 Appendix XI for field testing are the same as in ASTM F959-90, 0.015 inches for plain finished DTIs, and 0.005 inches for epoxy coated or galvanized DTIs.

Finally, nuts used with galvanized bolts have been slightly modified since the early 1990's. Galvanized nuts are now coated with a dry lubricant which significantly reduces the effects of seizing.

Samples from two different manufacturers of F959-96 DTIs were tested to compare their performance to those DTIs manufactured to F959-90, which came from only one supplier.

Results from the ASTM F959-96 Annex A1 tests for plain finished bolts are shown in Figure 16 and Figure 17, the results for galvanized DTIs are shown in Figure 18 and Figure 19, and the results for epoxy coated DTIs are shown in Figure 20 and Figure 21. Note that the specified DTI gap for all types of DTI finishes is 0.015 inches.

These graphs reveal minor variations between the DTIs from the two manufacturers. In some cases the slope of the Load vs. DTI gap is steeper for the DTIs produced by Manufacturer # 1. On the other hand, the DTIs from Manufacturer #2 occasionally have slightly less variability, expressed by the difference between the average and the 95% lower bound values. It should be emphasized that the DTIs from both manufacturers reliably indicated the required minimum tension at the specified DTI gap.

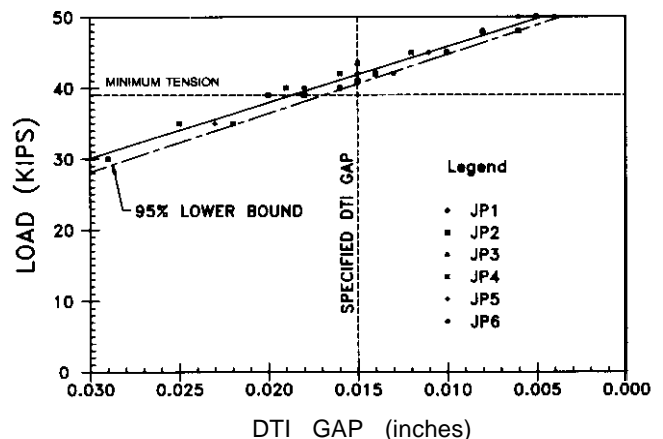

Fig. 16. F959-96 Annex A1—Load vs. DTI Gap, 7/8-in. A325 Plain Bolts with Plain DTIs, MFR #1

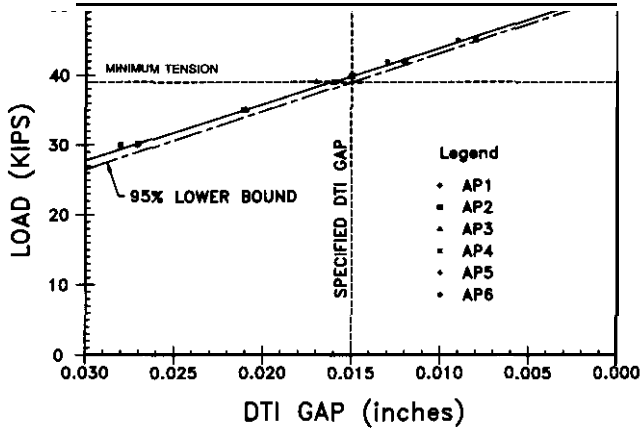

Fig. 17. F959-96 Annex A1-load vs. DTI Gap, 7/8-in. A325 Plain Bolts with Plain DTIs MFR #2

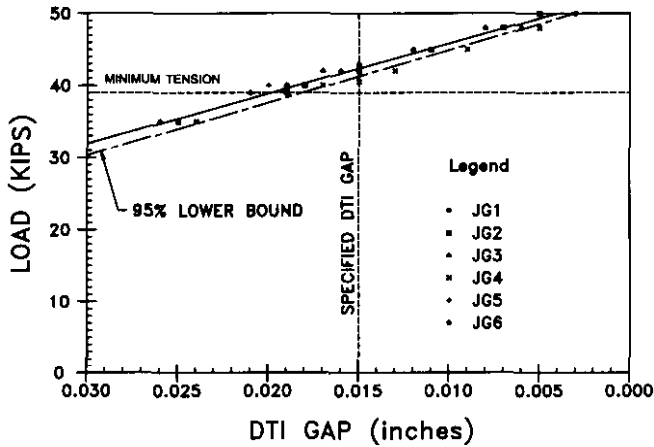

Fig. 18. F959-96 Annex A1—Load vs. DTI Gap, 7/8-in. A325 Galvanized Steel Bolts with Galvanized DTIs, MFR #1

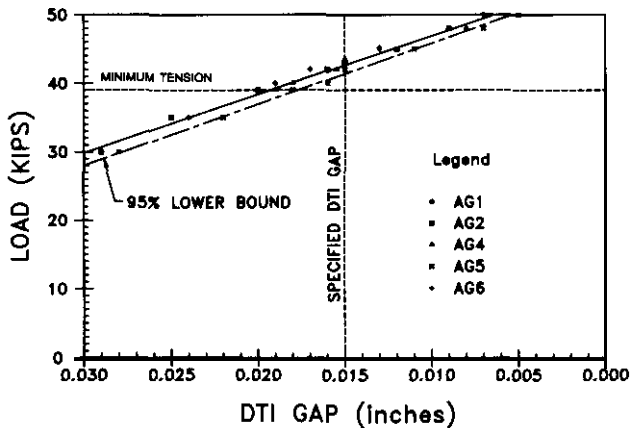

Fig. 19. F959-96 Annex A1-load vs. DTI Gap, 7/8-in. A325 Galvanized Bolts with Galvanized DTIs, MFR #2

Results of Field Tests

Results from the ASTM F959-96 Appendix XI "Field" tests for 7/8-inch A325 plain finished bolts with plain finished DTIs are shown in Figure 22 and Figure 23, the results for galvanized bolts with galvanized DTIs are shown in Figure 24 and Figure 25, and the results for weathering steel bolts with epoxy coated DTIs are shown in Figure 26 and Figure 27.

Note that for field tests the specified DTI gap is 0.015 inches for plain finished DTIs and 0.005 inches for epoxy coated or galvanized DTIs.

The field tests checked the performance of a DTI installed against a bolt head, not against a test machine bearing block. A feeler gauge was used to measure DTI gaps, rather than a direct reading gauge. The result of these two

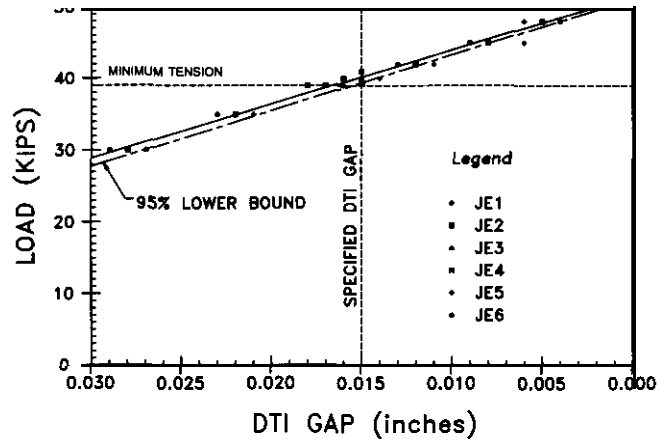

Fig. 20. Annex A1 -F959-96 Load vs. DTI Gap, 7/8-in. A325 Weathering Steel Bolts with Epoxy Coated DTIs, MFR #1

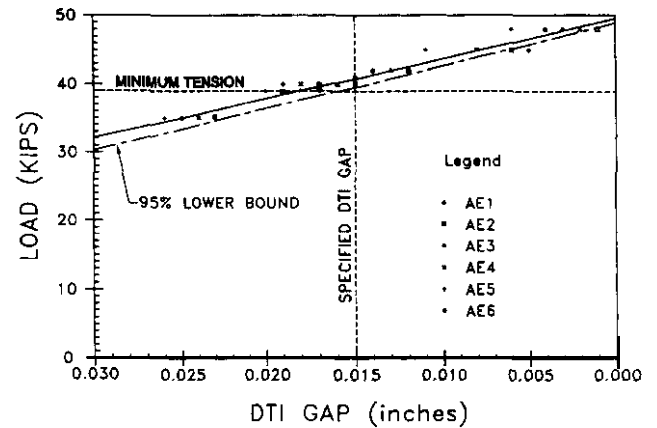

Fig. 21. F959-96 Annex A1-Load vs. DTI Gap, 7/8-in. A325 Weathering Steel Bolts with Epoxy Coated DTIs, MFR #2

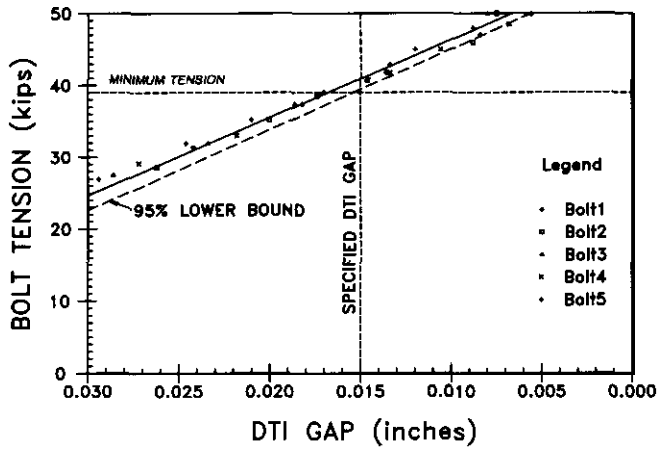

Fig. 22. Bolt Tension vs. Average DTI Gap, Field Measurements, 7/8-in. A325 Plain Bolt with Plain DTIs, MFR #1

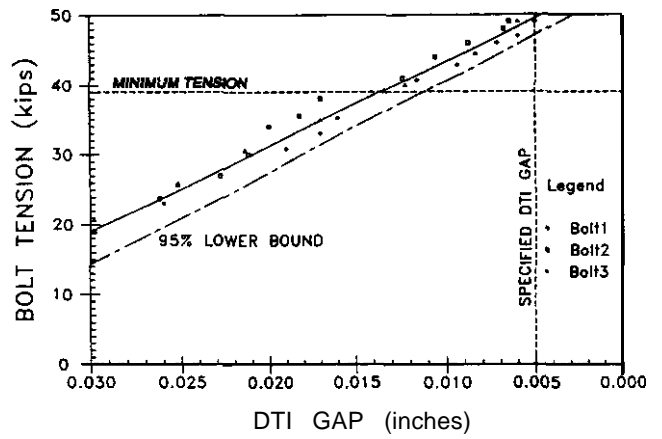

Fig. 25. Bolt Tension vs. Average DTI Gap, Field Tests, 7/8-in. A325 Galvanized Bolts with Galvanized DTIs, MFR #2

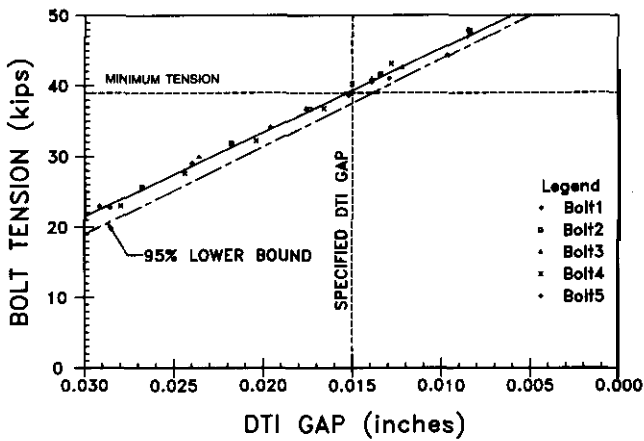

Fig. 23. Bolt Tension vs. Average DTI Gap, Field Measurements, 7/8-in. A325 Plain Bolts with Plain DTIs, MFR #2

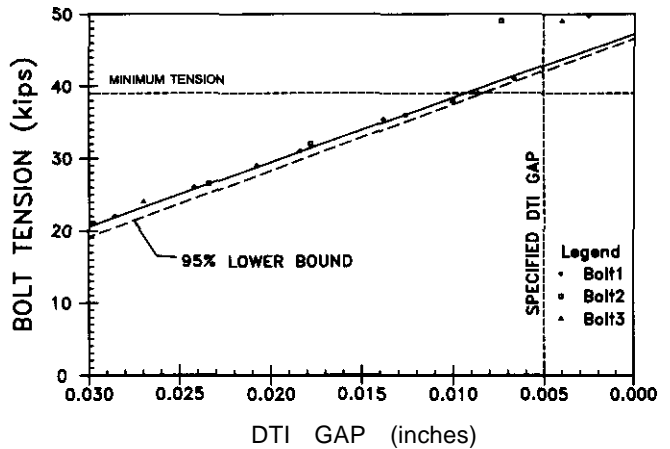

Fig. 26. Bolt Tension vs. Average DTI Gap, Field Tests, 7/8-in. A325 Weathering Steel Bolts with Epoxy Coated DTIs, MFR #1

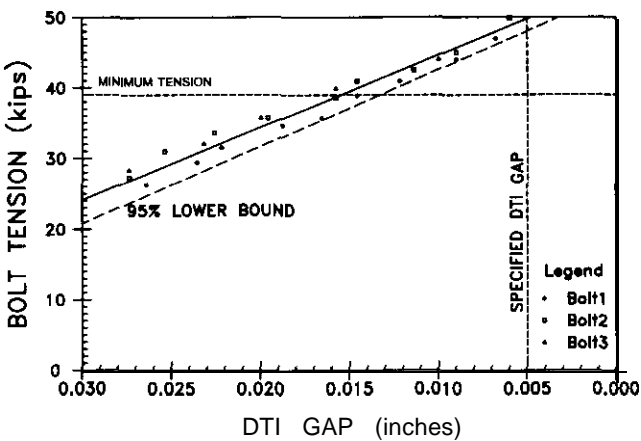

Fig. 24. Bolt Tension vs. Average DTI Gap, Field Tests 7/8-in. A325 Galvanized Bolts with Galvanized DTIs, MFR #1

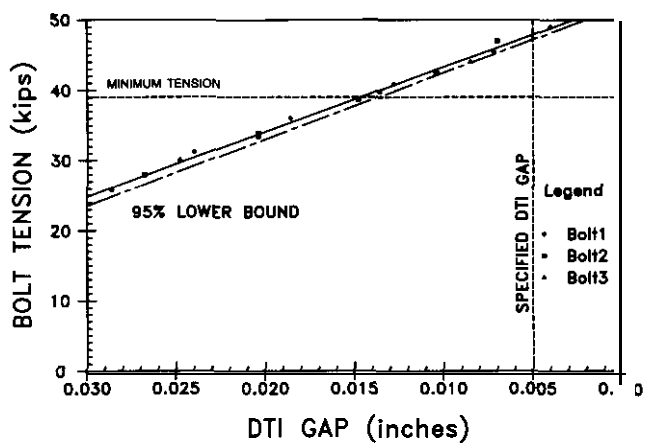

Fig. 27. Bolt Tension vs. Average DTI Gap, Field Tests 7/8-in. A325 Weathering Steel Bolts with Epoxy Coated DTIs, MFR #2

factors was more variability in field test results compared to those obtained using the mandatory F959-96 Annex A1 test.

Summary and Observations-Appendix

The following observations can be made from the tests on DTIs manufactured to F959-96.

The DTIs manufactured to F959-96 show less variation than those manufactured to earlier specifications. For example, comparing Figure 7, Figure 20, and Figure 26, the epoxy coated DTIs manufactured to the F959-96 specification indicated higher loads at the specified DTI gap than did the DTIs produced to the earlier specifications. Galvanized DTIs manufactured to F959-96 also indicated greater loads at the specified DTI gap than those manufactured to earlier specifications.

DTI gap measurements made using feeler gauges showed more variability than those made using direct reading gauges. In addition, DTI gap measurements made using feeler gauges indicated lower loads than those made using direct reading gauges.

The results of these tests did not reveal any significant differences between the DTIs from the two different vendors. DTIs from both vendors met the requirements of F959-96.

ACKNOWLEDGMENTS

The research in this report was jointly sponsored by the Idaho Transportation Department and the University of Idaho. Test equipment, bolts, washers, nuts, and DTIs were supplied by J&M Turner, Inc. and Applied Bolting Technology Products, Inc.

REFERENCES

1. Research Council on Structural Connections, *Load and Resistance Factor Design Specifications for Structural Joints Using ASTM A325 or A490 Bolts*, AISC, Chicago, IL, 1994.
2. American Association of State Highway and Transportation Officials, *Standard Specifications for Highway Bridges*, 16th Edition, Washington, DC., 1996, Section 11.5.6.4.7.

3. Bendigo, R.A., and Rumpf, J.L. *Calibration and Installation of High Strength Bolts*, Fritz Engineering Laboratory Report No. 271.7, 1959.
4. Stmik, J.H.A., Abayomi, O.O., and Fisher, J.W., "Bolt Tension Control with a Direct Tension Indicator," *Engineering Journal*, American Institute of Steel Construction, Vol. 10, No. 1, 1973, p. 1.
5. Salih, N., Smith, J. Aktan, H.M. and Mumtaz, U., "An Experimental Appraisal of the Load-Deflection Properties of A325 High-Strength Bolts," *Journal of Testing and Evaluation*, Vol. 20, No. 6, 1992, p. 440.
6. J&M Turner, Inc., *Instruction Manual for Installing High-Strength Bolts with Direct Tension Indicators, Inch Series Edition*, Southampton, PA, 1993.
7. American Society of Testing and Materials, "Standard Specification for Compressible-Washer-Type Direct Tension Indicators for Use with Structural Fasteners," *ASTM Designation: F959-90*, Philadelphia, PA, 1990.
8. Brockenbrough, R.L., "Considerations in the Design of Bolted Joints for Weathering Steel," *Engineering Journal*, American Institute of Steel Construction, Vol. 20, No. 1., 1983, pp. 40-45.
9. Kulak, G.L., Fisher, J.W., and Stmik, J.H., *Guide to Design Criteria for Bolted and Riveted Joints*, John Wiley & Sons, NY, 1987.
10. Chesson, E. Jr., Faustino, N.L. and Muse, W.H., "High-strength Bolts Subjected to Tension and Shear," *Journal of the Structural Division*, ASCE Vol. 91 ST5, 1965, p. 40.
11. Christopher, R. J., Kulak, G.L., and Fisher, J.W., "Calibration of Alloy Steel Bolts," *Journal of the Structural Division*, ASCE, Vol. 92, ST2, April 1966.
12. American Society of Testing and Materials, "Standard Specification for Compressible-Washer-Type Direct Tension Indicators for Use with Structural Fasteners," *ASTM Designation: F959-96*, Philadelphia, PA, 1996.